

PCI312PUSB/LP & PEX312PUSB/LP PCI/PCIe 12V Powered USB Card

PUSBADAP/LP 12V/24V Daughter Card

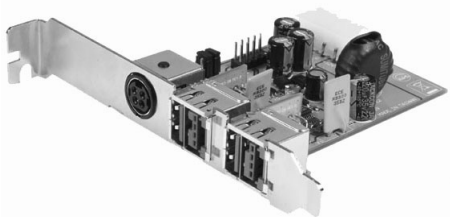
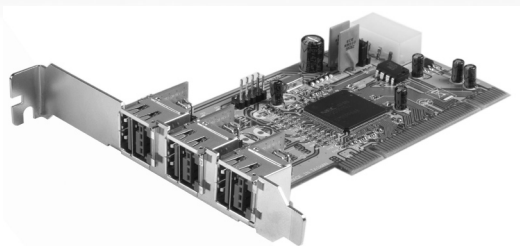

FCC Compliance Statement

This equipment has been tested and found to comply with the limits for a Class B digital device, pursuant to part 15 of the FCC Rules. These limits are designed to provide reasonable protection against harmful interference in a residential installation. This equipment generates, uses and can radiate radio frequency energy and, if not installed and used in accordance with the instructions, may cause harmful interference to radio communications. However, there is no guarantee that interference will not occur in a particular installation. If this equipment does cause harmful interference to radio or television reception, which can be determined by turning the equipment off and on, the user is encouraged to try to correct the interference by one or more of the following measures:

- Reorient or relocate the receiving antenna.
- Increase the separation between the equipment and receiver.
- Connect the equipment into an outlet on a circuit different from that to which the receiver is connected.
- Consult the dealer or an experienced radio/TV technician for help.

Use of Trademarks, Registered Trademarks, and other Protected Names and Symbols

This manual may make reference to trademarks, registered trademarks, and other protected names and/or symbols of third-party companies not related in any way to StarTech.com. Where they occur these references are for illustrative purposes only and do not represent an endorsement of a product or service by StarTech.com, or an endorsement of the product(s) to which this manual applies by the third-party company in question. Regardless of any direct acknowledgement elsewhere in the body of this document, StarTech.com hereby acknowledges that all trademarks, registered trademarks, service marks, and other protected names and/or symbols contained in this manual and related documents are the property of their respective holders.

Table of Contents

Introduction	1
Features	1
Package Contents	1
Hardware Guide	2
PCI312PUSB/LP, PEX312PUSB/LP	2
Jumper Settings.....	2
PUSBADAP/PUSBADAPLP	3
Hardware Installation	4
PCI312PUSB/LP, PEX312PUSB/LP & PUSBADAP/LP	4
PCI312PUSB/LP or PEX312PUSB/LP Only	5
PUSBADAP/PUSBADAPLP Only	6
Software Installation	7
Specifications	8
Technical Support	9
Warranty Information	9

Introduction

Thank you for purchasing a StarTech.com Powered USB 2.0 Adapter Card (available in both PCI and PCI Express formats as well as Standard and Low Profile). Now, adding Powered USB capability to a computer has never been easier!

Fully compatible with USB1.1 OHCI and USB2.0 EHCI specifications, the cards support data speeds of up to 480 Mbps and provide power to Powered USB devices through industrial standard Powered USB connectors.

Features

- Supplies power and data signals over hot-pluggable USB cable
- Mainboard can be linked to daughter board
- Daughter board and Main board can be used as stand alone devices
- Selectable power input
- Connectors offer cable locking mechanism

Package Contents

- PCI312PUSB/LP: 1 x Powered USB Mainboard Card
or
PEX312PUSB/LP: 1 x Powered USB Mainboard Card
or
PUSBADAP/LP: 1 x Powered USB Daughter Board
- Instruction Manual
- Driver CD (PCI312PUSB/LP and PEX312PUSB/LP only)
- 9-Pin USB Header Cable (PUSBADAP/LP Only)

Please note that the Powered USB ports are color coded based on voltage capability they support, as follows:

Yellow: 5V

Green: 12V

Red: 24V

Hardware Guide

PCI312PUSB/LP, PEX312PUSB/LP

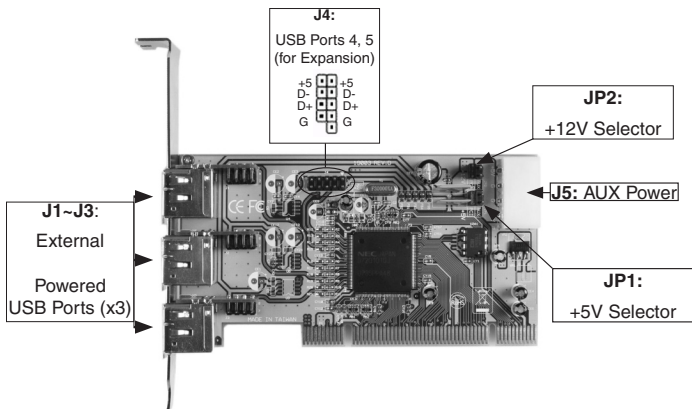

Jumper Settings

JP1 (+5V Selector)	Settings
<p>Default: The USB2.0 Bus Power is supplied by the motherboard PCI slot (DC+5V supplied from PCB)</p>	
<p>The USB2.0 Bus Power is supplied by the AUX power connector (J5).</p> <p>This option provides more power for Powered USB devices, but requires a connection to the computer power supply.</p>	



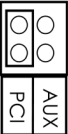
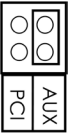

Jumper Settings - Cont'd

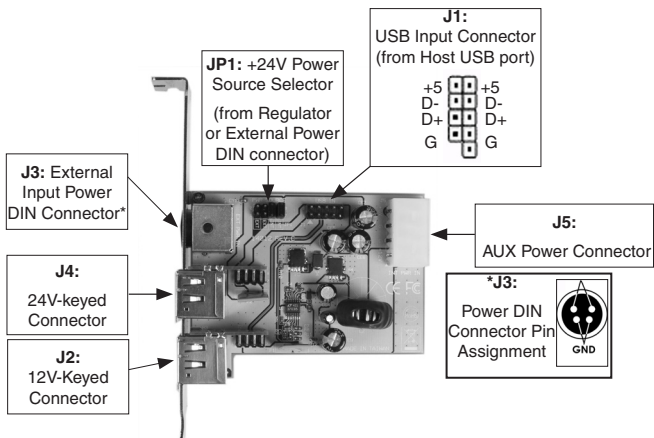
JP2 (+12V Selector)	Settings
<p>Default: The 12V power source of the Powered USB connectors are supplied by the PCI slot into which the card is installed</p>	
<p>The 12V power source of the Powered USB connectors are supplied by the AUX power connector (J5). This will require that a power cable be connected from the computer power supply to J5. This option provides more power for the Powered USB devices over the USB2.0 cable.</p>	

PUSBADAP/PUSBADAPLP

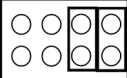

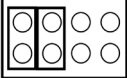
Jumper Settings

JP2 (24V Selector)	Settings
<p>Default: The power source of the 24V-keyed PoweredUSB connector is supplied from the internal step-up switching regulator (jumpers must be set identically, both at INT or EXT).</p>	 
<p>The power source of the 24V-keyed Powered USB connector is supplied from the external Power DIN input connector, in this case, a 24V AC adapter will be required. Please see http://www.startech.com for more information.</p>	 

Hardware Installation

PCI312PUSB/LP, PEX312PUSB/LP & PUSBADAP/LP

This section details how to install PCI312PUSB/PEX312PUSB, in conjunction with a daughter board, PUSBADAP:

1. Remove the computer cover. For more detailed instruction on how to perform this step, please refer to the documentation that was included with your computer at the time of purchase.
2. Locate an empty PCI/PCI Express slot and remove the metal bracket covering the accompanying empty port/socket.
3. Connect one end of the **9-pin Header Cable** (provided by PUSBAD/LP) to the expansion port (depicted on pg. 2 as **J4:USB Ports 4, 5**).
4. Position the card above the open PCI/PCI Express slot, ensuring that the card is properly aligned with the slot. Insert the card firmly into the slot, distributing force evenly across the length of the board, then fasten the metal bracket to the computer case (using the screw removed in step #2).

- Remove a metal bracket that is adjacent to or near the one removed in step #2, and fasten PUSBADAP/PUSBADAPLP directly to the metal rear panel of the computer case.
- Connect the remaining end of the 9-Pin USB Header Cable used in step #3, to the **USB IN** connector, denoted as **J1: USB Input Connector** (from Host USB port) (see diagram, pg.3) on the PUSBADAP board.
- PCI312PUSB/PEX312PUSB:** By default, **JP2** (see pg. 3) is set to **PCI**. The card will draw power via the PCI/PCI Express slot into which it is installed; as such, if you've left the **JP2** jumper in the default position, there will be no need to connect PCI312PUSB to the computer power supply.

If **JP2** has been switched to **INT** (Internal), you must connect PCI 312PUSB/PEX312PUSB to the computer power supply, by inserting an available LP4 connector into the **AUX Power Connector**.

PUSBADAP: By default, **JP2** is set to **INT**, commanding the card to draw power from the computer power supply. As such, insert an LP4 power connector from the power supply, into the AUX Power Connector.

If **JP2** has been set to **EXT**, the PUSBADAP will draw power through the External Input Power DIN Connector, and will require an external power source (see <http://www.startech.com> for accessories).

- Once both cards have been properly positioned, and the necessary link has been made between them, close the computer case and power on the computer.

PCI312PUSB/LP or PEX312PUSB/LP Only

This section details how to install PCI312PUSB/PEX312PUSB as a stand alone card.

- Remove the computer cover. For more detailed instruction on how to perform this step, please refer to the documentation that was included with your computer at the time of purchase.

2. Locate an empty PCI/PCI Express slot and remove the metal bracket covering the accompanying empty port/socket.
3. Position the card above the open PCI/PCI Express slot, ensuring that the card is properly aligned with the slot. Insert the card firmly into the slot, distributing force evenly across the length of the board, then fasten the metal bracket to the computer case (using the screw removed in step #2, if necessary).
4. By default, **JP2** (see pg. 3) is set to **PCI**, commanding the card to draw power via the PCI slot into which it is installed. As such, if you've left the JP2 jumper in the default position, there will be no need to connect PCI312PUSB to the computer power supply.

If **JP2** has been switched to **INT** (Internal), you must connect PCI 312PUSB to the computer power supply, by inserting an available LP4 connector into the **AUX Power Connector**.

5. Once the card is properly seated, and secured to the computer case, close the computer case and power on the computer.

PUSBADAP/PUSBADAPLP Only

This section details how to install PUSBADAP as a stand alone card.

1. Remove the computer cover. For more detailed instruction on how to perform this step, please refer to the documentation that was included with your computer at the time of purchase.
2. Connect one end of the 9-Pin USB Header Cable (provided) to the **USB IN** connector, denoted as **J1: USB Input Connector (from Host USB port)** (see diagram, pg.3) on the PUSBADAP board.
3. By default, **JP2** is set to **INT**, commanding the card to draw power from the computer power supply. As such, insert an LP4 power connector from the power supply, into the AUX Power Connector.

If **JP2** has been set to **EXT**, the PUSBADAP will draw power through the External Input Power DIN Connector.

4. Connect the remaining end of the 9-Pin USB Header Cable (see step

#2), to the USB Header connector on the host motherboard. For further instructions on how to locate the appropriate connection on the motherboard, please consult the documentation that was included with your motherboard/computer at the time of purchase.

Software Installation

PCI312PUSB/LP and PEX312PUSB/LP are natively supported by Windows® XP (SP2) 2000 (SP4) and Vista™. As such, no driver installation is required, as long as the necessary updates have been made to the operating system(s).

For **Windows 98SE** or **Windows ME** installations, however, driver installation is required.

To install the drivers necessary for PCI312PUSB/LP or PEX312PUSB/LP to function properly:

1. With the host computer powered on, insert the Driver CD that accompanied your purchase of PCI312PUSB/PCI312PUSBLP into the CD/DVD-ROM drive.
2. On the Driver CD, browse to the **X:\USB 2.0\NEC** folder, (where **X** denotes the designated CD/DVD-ROM drive on the host computer) and locate the folder that corresponds with the host computer operating system.
3. Open the appropriate folder and locate the **U2v2_1** application file. Execute the file by double clicking on the icon/listing, to begin installation.
4. Follow the installation through until you are asked if you would like to reboot the computer. Select **Yes, I want to restart my computer now** and click on **Close**.

Once the computer has rebooted, the operating system will detect the presence of the card - installation is complete.

Specifications

	PCI312PUSB	PEX312PUSB	PUSBADAP
Connectors	3 x 12V Powered USB male connectors 1 x LP4 Connector 1 x Internal USB (9 pin) Header Connector for expansion 1x Jumper Connector		1x 12v Power USB Connector 1x 24v Power USB Connector 1x 4 pin Power Din Connector 1x Internal USB Connector 1x Jumper Connector 1x LP4 Connector
OS Support	Windows® 2000/ME/2003/XP/Vista™		
Dimensions (L x W)	81.2 mm x 66.7 mm (3.2 in) x (2.63 in)		120 mm x 66.7 mm (4.72 in) x (2.63 in)
Regulatory Certified	CE, RoHS, FCC		
Maximum Data Transfer Rate	480Mbps		
Chipset	NEC D720101GJ	NEC D720101GJ + TI XIO2000A PCI Express to PCI Bus Translation Bridge	N/A

Technical Support

StarTech.com's lifetime technical support is an integral part of our commitment to provide industry-leading solutions. If you ever need help with your product, visit www.startech.com/support and access our comprehensive selection of online tools, documentation, and downloads.

Warranty Information

This product is backed by a lifetime warranty. In addition, StarTech.com warrants its products against defects in materials and workmanship for the periods noted, following the initial date of purchase. During this period, the products may be returned for repair, or replacement with equivalent products at our discretion. The warranty covers parts and labor costs only. StarTech.com does not warrant its products from defects or damages arising from misuse, abuse, alteration, or normal wear and tear.

Limitation of Liability

In no event shall the liability of StarTech.com Ltd. and StarTech.com USA LLP (or their officers, directors, employees or agents) for any damages (whether direct or indirect, special, punitive, incidental, consequential, or otherwise), loss of profits, loss of business, or any pecuniary loss, arising out of or related to the use of the product exceed the actual price paid for the product. Some states do not allow the exclusion or limitation of incidental or consequential damages. If such laws apply, the limitations or exclusions contained in this statement may not apply to you.



StarTech.com has been making “hard-to-find easy” since 1985, providing high quality solutions to a diverse IT and A/V customer base that spans many channels, including government, education and industrial facilities to name just a few. We offer an unmatched selection of computer parts, cables, A/V products, KVM and Server Management solutions, serving a worldwide market through our locations in the United States, Canada, the United Kingdom and Taiwan.

Visit **www.startech.com** today for complete information about all our products and to access exclusive interactive tools such as the Cable Finder, Parts Finder and the KVM Reference Guide. StarTech.com makes it easy to complete almost any IT or A/V solution. Find out for yourself why our products lead the industry in performance, support, and value.